

.....The Engineered Mist Eliminator

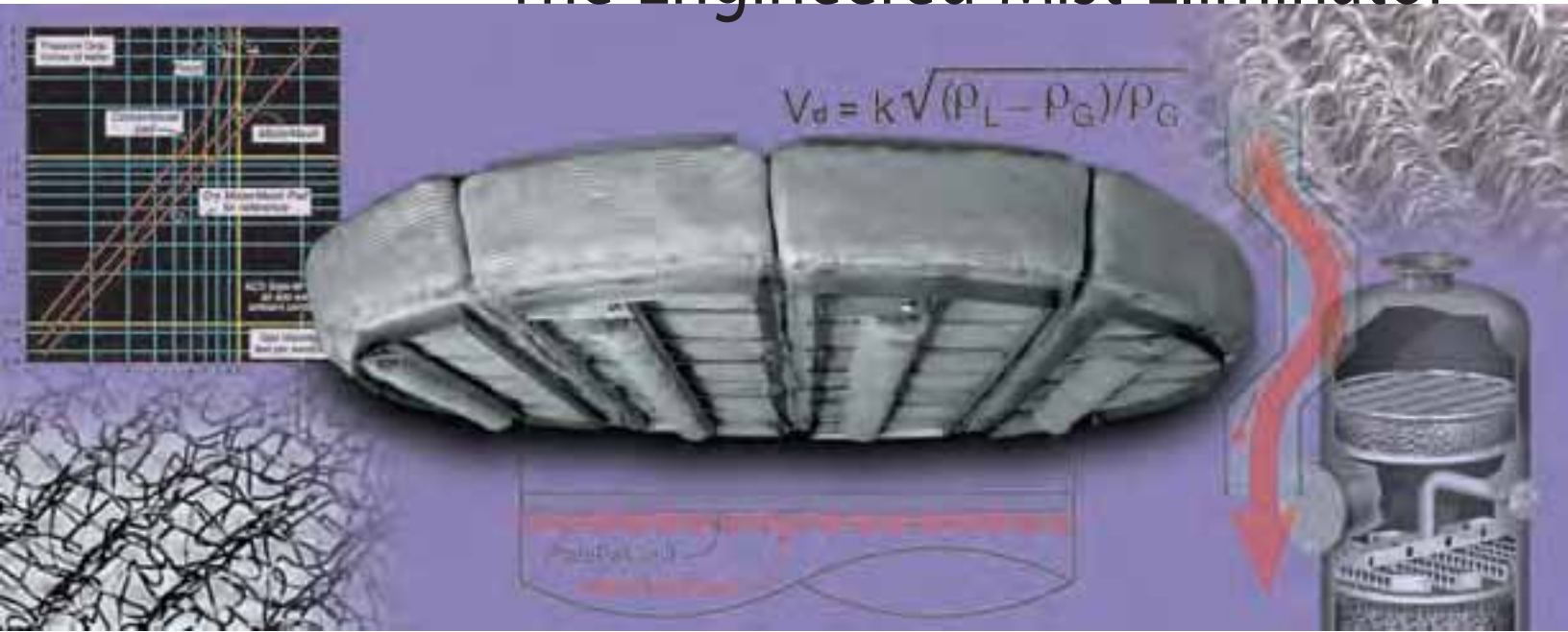

REDUCE COSTS

INCREASE CAPACITY

IMPROVE PERFORMANCE

DEBOTTLENECK EQUIPMENT

SIMPLIFY INSTALLATION

CUSTOMIZE PADS



AMACS

PROCESS TOWER INTERNALS

800-231-0077

14211 Industry Street • Houston, TX 77053 • TEL: 713-434-0934 • FAX: 713-433-6201
Email: amacs@amacs.com • Visit our website www.amacs.com

Table of Contents

Introduction	1
Droplet Formation and Size Distributions	1
Mechanisms of Droplet Removal	2
Types of Mist Eliminator Mesh & Materials	4
Design Equations	6
Predicting Pressure Drop	7
Inlet Diffusers	7
Vessel Configuration	8
Advanced Mist Eliminator Designs	10
Mesh-Vane Assemblies	11
Use of Geometry	11
MultiPocket® Vanes	11
Pockets Improve Efficiency	12
MaxCap® Mist Eliminator	14
Case Studies & Examples	15

Plate-Pak™ and AccuFlow™ are trademarks of AMACS Process Tower Internals. MisterMesh® and MultiPocket® are registered trademarks of AMACS Process Tower Internals. The information contained in this bulletin is believed to be accurate and reliable but is not to be construed as implying any warranty or guarantee of performance.

The Engineered Mist Eliminator

Mist elimination, or the removal of entrained liquid droplets from a vapor stream, is one of the most commonly encountered processes regardless of unit operation. Unfortunately, mist eliminators are often considered commodity items and are specified without attention to available technologies and design approaches. The engineered mist eliminator may reduce liquid carryover by a factor of one hundred or more relative to a standard unit, drop head losses by 50% or more, or increase capacity by factors of three or four. This manual summarizes input practical approaches to reducing absorbent losses, product contamination and entrainment carry over, extending equipment life and maintenance cycles - using proven and cost effective technologies and techniques.

Droplet Formation and Size Distributions

Entrained liquid does not consist of same-sized droplets, but as a broad range of droplet sizes that may be characterized with a Normal or Bell Distribution centered about some mean or average. The average droplet size depends very much on the mechanism by which they are generated. Sizing equations are expressed in terms of the probability of removing a droplet of a given diameter, and mist eliminator performance is the integration or cumulative sum of individual removal efficiencies. It is therefore critical to know the approximate droplet size distribution in order to properly design a mist elimination system. Figure 1 shows some

typical size distribution curves from different sources.

In practice, designers or engineers do not quantify or measure droplet size distributions, rather they are assumed based on empirical data or experience. Fortunately, an experienced engineer can assume an approximate distribution based on the means or mechanism

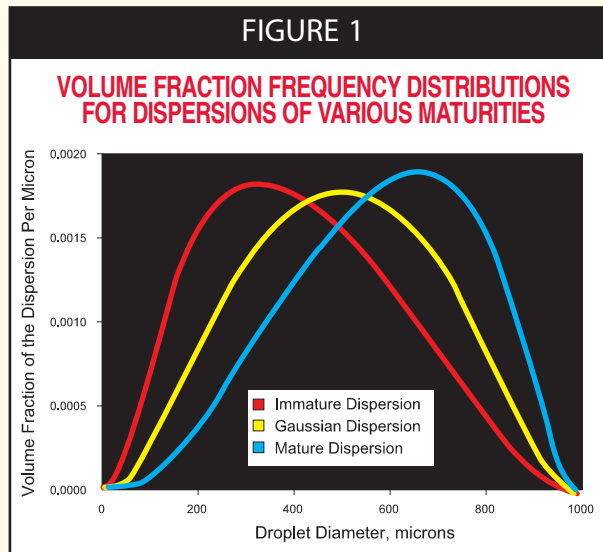

by which the droplets are generated. Typical examples from common mist sources are given to illustrate these concepts.

Fine droplet distributions, often called *fogs* (<3 μm diameter particles with an average typically in the submicron range), occur in high speed metal stamping in which cycles of extreme frictional heating and shock condensation of lubricating oils form droplets in the submicron range, so-called "blue smoke". This smoke is removed to comply with health and environmental regulations.

Fog is also produced when gas phase reactions form a liquid product as in the case of vapor phase SO_3 and water yielding H_2SO_4 . Downstream

equipment corrodes rapidly without the removal of this liquid. Similar concerns are found in ammonia prill towers, many chlorine applications, as well as phosphoric and nitric acid plants.

A *mist* consists of droplets in the range of 3 μ m and greater, though distributions with average diameters of 20 μ m and greater are termed *Sprays*. Mist coming off the top of packing or trays, or generated by surface evaporation, are typically in the broad range of 5-800 μ m. In towers used in glycol dehydration and amine sweetening in which mists are a major source of costly solvent losses, removal of droplets down to 5 μ m is recommended.

Hydraulic spray nozzles generate particles with diameters greater than 50 μ m and pneumatic nozzles generate particles with diameters greater than 10 μ m, with upper limits reaching 1000 μ m.

The first step in engineering a mist eliminator is to determine the mechanism by which the droplets are generated and assume an average droplet size. Figure 2 summarizes typical particle size distributions caused by various mechanisms:

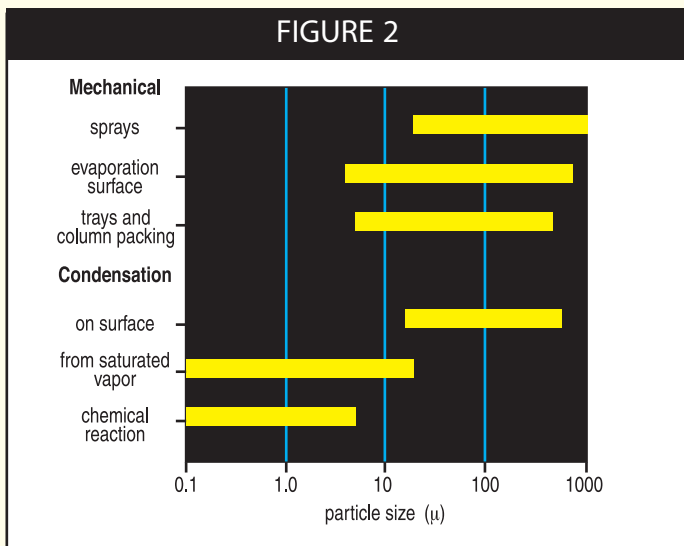

This manual contains basic design concepts used by engineers to remove droplets greater than 3 μ m in diameter, so called mists and sprays.

Mechanisms of Droplet Removal

Droplets are removed from a vapor stream through a series of three stages: collision & adherence to a target, coalescence into larger droplets, and drainage from the impingement element. Knowing the size distributions as explained above is important because empir-

ical evidence shows that the target size - important in the first step of removal - must be in the order of magnitude as the particles to be removed. These steps are shown schematically in Figure 3 for mist elimination using a wire mesh mist eliminator.

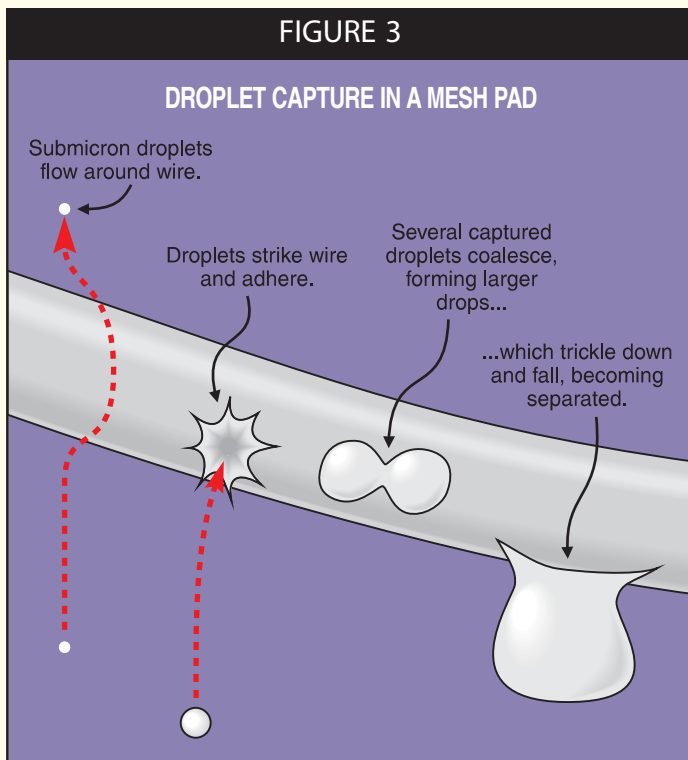

For fogs in which the bulk of the droplets are characterized with submicron diameters, the energy to bring about the collision with the target is derived from Brownian Diffusion, the random motion of fine liquid particles as they are pushed about by molecular action as shown in Figure 4a. Fog elimination with so-called fiberbed technology is beyond the scope of this manual.

For particles in the mist region between 3-20 μ m, knitted wire mesh is the most common type of mist eliminator used and interception is the primary mechanism.

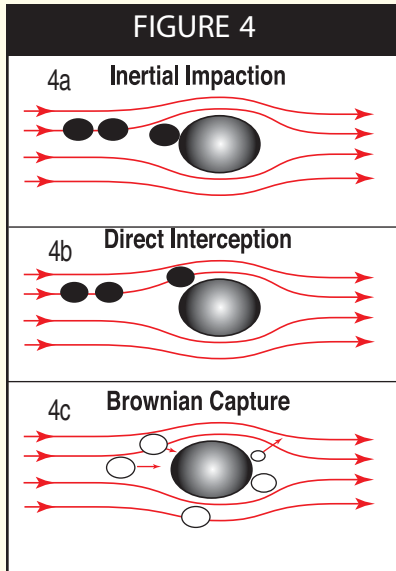

Consider a droplet approaching a mesh filament of much larger diameter as shown in Figure 4b. The more dense the droplet relative to the gas, the larger the droplet relative to the filament, and the higher the gas velocity, the more likely it is that the droplet will strike the filament. If the velocity is too low, or the droplet too small or too light compared to the gas, the droplet will simply flow around the filament with the gas. If the velocity is too high, liquid clinging to the filaments will be re-entrained, mostly as larger droplets, and carried away by the gas. Re-entrainment is also promoted by low relative liquid density (making it easier for the gas to pick up a droplet) and low liquid surface tension (as less energy is required to break up a film or droplet). The engineered wire mesh mist eliminator may remove 99.9% of particles 2 μm and greater diameter. Figure 5 shows a typical removal efficiency vs droplet size distribution for a wire mesh mist eliminator.

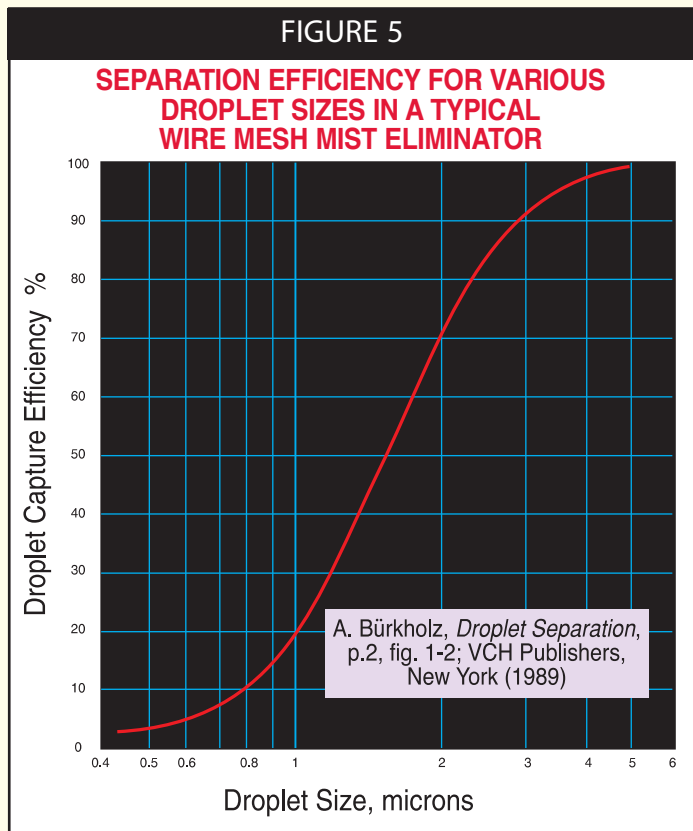

Droplets $\sim 20 \mu\text{m}$ and greater are primarily collected by means of Inertial Impaction whereby the target is directly in the path of the streamline, as shown in Figure 4c. Figure 6 depicts a profile of the ACS Plate-Pak™ vane. The entrained droplets, due to their

momentum, tend to move in straight lines. By studying this figure, it is easy to understand why in the design equations to follow the removal efficiency is directly proportional to the difference in densities of the liquid droplet and carrying gas. With each change in direction of the gas, some droplets collide with the surface and adhere, eventually coalescing into larger droplets which then drain by gravity. Properly designed vane mist eliminators can remove 99% of particles as low as 10 μm in diameter, especially at lower pressures.

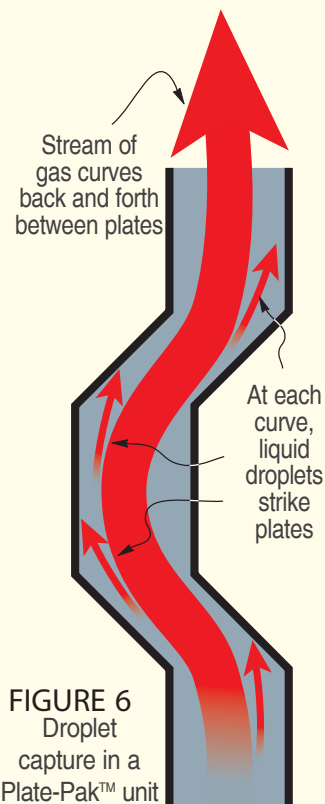

Figure 7 illustrates typical wire mesh and Plate-Pak™ vane mist eliminators, and Figure 8 shows some typical performance curves for both mesh and vane mist eliminators.

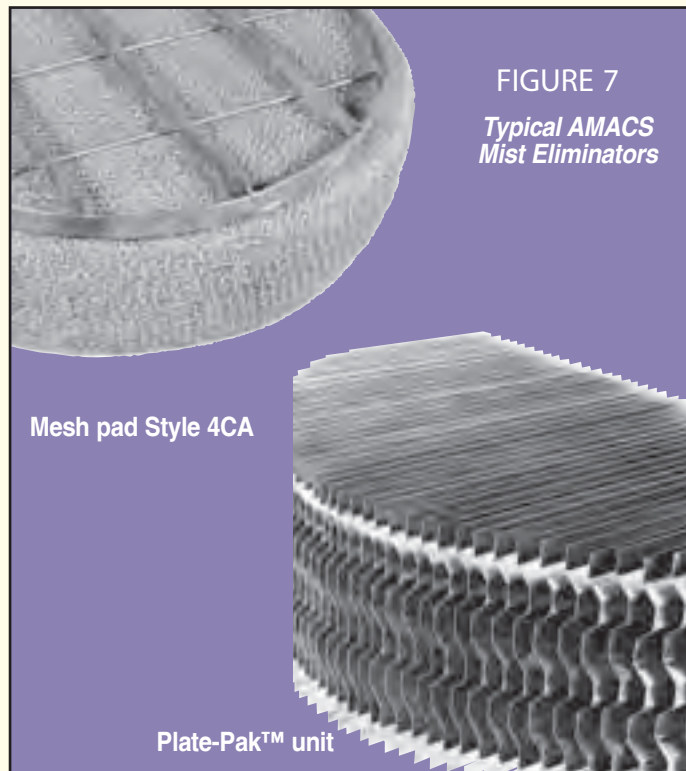
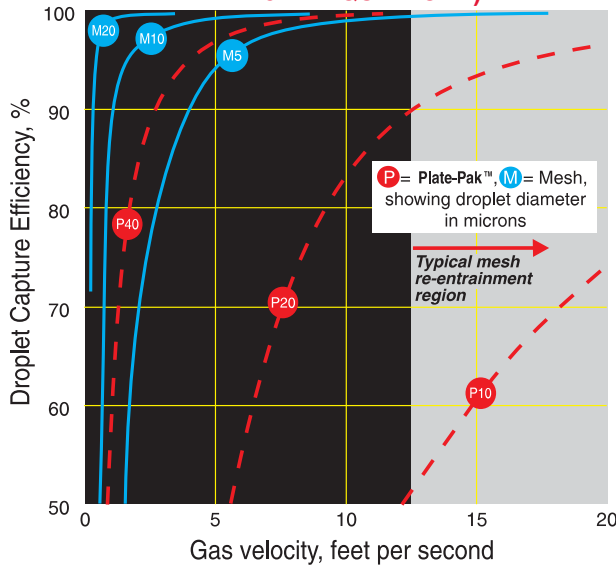

FIGURE 8

THEORETICAL EFFICIENCY VS. VELOCITY FOR VARIOUS DROPLET SIZES (WATER IN AIR AT AMBIENT CONDITIONS FOR TYPICAL MESH PADS AND PLATE-PAK™ UNITS WITH LIGHT LIQUID LOAD)



It is worthwhile to discuss Fig. 8 and mist eliminator performance. The dotted curves correspond to different styles of vanes and the solid to wire mesh styles. Note first of all that vanes can be engineered to operate at higher gas velocities and flow rates relative to mesh, but that mesh mist eliminators can approach 100% removal efficiency at smaller droplet sizes. This agrees with the discussions above on Interception and Inertial Impaction removal mechanisms. Note the drastic efficiency drop off at low velocities, in which droplets drift around the filaments or vane blades without striking them. This phenomenon defines the lower operating range of a mist eliminator. The other extreme is when the velocity is too high. In this case, the droplets are captured but the velocity of the gas provides sufficient energy to tear-off and re-entrain droplets. It is in the context of re-entrainment that the design equations which follow show that the removal efficiency is directly proportional to the surface tension of the liquid. As the surface tension increases, so it requires greater kinetic energy (i.e. gas velocity) to break the bond between droplet and target, and the droplets collect and coalesce until drainage by gravity. Re-entrainment defines the upper capacity limit of a mist eliminator.

Operating range is also affected by the liquid loading (proportion of liquid) of the gas. If too great, the mist

eliminator becomes choked with liquid, a condition called flooding. Flooding is often noticed by high pressure drops or massive carryover of liquids. Typical wire mesh mist eliminators accommodate liquid loads up to about one US GPM per square foot and vanes twice as much.

The key operating ranges and suitability of mesh and vane mist eliminators are summarized in Figure 9. It emphasizes that vanes are more effective at higher velocities and greater droplet sizes while mesh is more suitable for removing smaller particles at lower velocities. Gravity settling alone is sufficient for very large particles, and co-knit mesh pads, discussed below, for particles in the range of sizes from 2-8 μm . Finally, fiberbed technology is used for submicron fogs.

FIGURE 9

APPROXIMATE OPERATING RANGES OF MIST ELIMINATORS

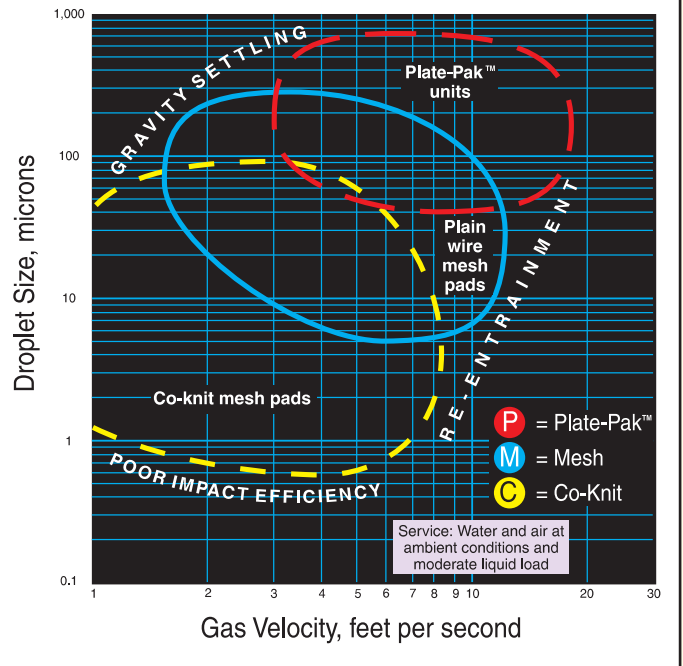

Types of Mist Eliminator Mesh Styles & Materials

Most designers believe that all wire mesh mist eliminators behave basically the same in terms of capacity and removal efficiency. It is true that for meshes of same filament diameter, the denser mesh offers superior removal efficiency. For meshes with differing filament diameters, a lighter (less dense) mesh may offer considerably better removal efficiency. The key is that the working part of the mesh is the target density, not

the mass density. For example, the most common 9-lb density mesh, AMACS style 4CA, exhibits ~85 sq-ft/cu-ft of surface area. Compare this to the co-knit of a metal with fiberglass (AMACS style 6BE) which also exhibits 9-lb mass density but exhibits a specific surface area approaching 3,700 sq-ft/cu-ft, some 40X greater targets per unit volume.

Table 1 shows a few of the more common mesh styles available, together with mesh density and void fraction, and most importantly, the diameter and specific surface area (i.e. the target density) of filaments used.

TABLE 1 • Wire and Plastic Mesh Styles

Mesh Style	Density lbs/ft ³	Diameter D, inches	Surface, S, ft ² /ft ³	Percent Voids, ε
Metal mesh				
7CA	5.0	0.011	45	99.0
5CA	7.0	0.011	65	98.6
4CA	9.0	0.011	85	98.2
4BA	12.0	0.011	115	97.6
3BF	7.2	0.006	120	98.6
3BA	12.0	0.006	200	97.6
Plastic mesh				
8P	4.0	0.011	130	92.0
8K	4.0	0.011	160	96.3
8T	4.0	0.011	130	97.0

Mesh Style	Density lbs/ft ³	Diameter D, inches	Surface, S, ft ² /ft ³	Percent Voids, ε
Metal mesh				
8D	9	0.0008	615	99.0
8TMW11	12	0.0008	1170	99.0
6BE	9	0.00036	3725	99.0
Plastic mesh				
8PP	3	0.001	480	99.0
8TT	5	0.0008	1240	99.0

It is the amount of targets per unit volume which influences removal efficiency, not the density of mesh (the greater the number of targets the greater the probability of a successful collision).

In a co-knit such as a metal alloy and fiberglass, the alloy provides a skeleton for structural support and prevents the high specific surface media from collapsing on itself.

As far back as the 1950's researchers (C. LeRoy Carpenter et al) determined that specific surface area and target or filament diameter play a great role in removal efficiency. Target or filament diameter must be on the order of magnitude as the smallest droplets to be removed. Due to limitations in metal wire ductility and corrosion considerations, co-knits provide finer targets and hence remove finer droplets. Figures 10 and 11 are enlarged images of crimped wire mesh and a co-knit with fiberglass respectively.

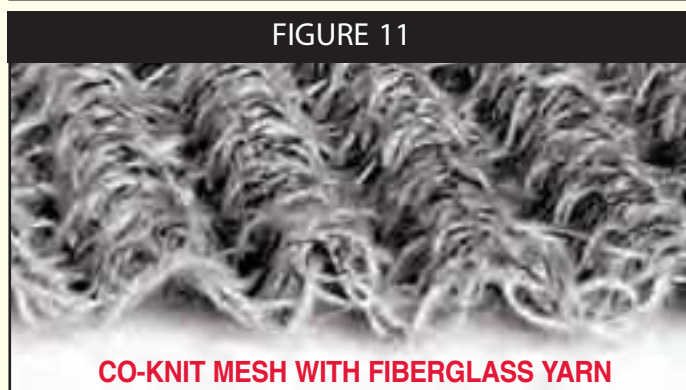
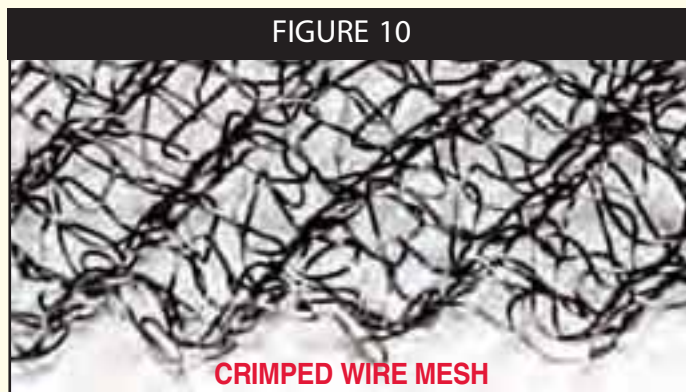

In summary, it is important to report mesh styles in terms of the specific surface area - a measure of the target density, and filament diameter - a measure of the smallest droplet size that can be removed with high efficiency. The mass density is only relevant insofar that a metal mesh of density 12-lb exhibits a greater specific surface area than one of density 7-lb provided the wire diameter remains constant.

Selecting the material of mesh style(s) is also important. Corrosion rates as low as 0.005"/year is not serious in vessel walls but will quickly destroy 0.006" or 0.011" wire mesh. Table 2 gives preliminary guidelines, but AMACS draws wire and knits mesh with any ductile metal for special applications.

When applying non-metal materials operating temperature limits must be considered.

TABLE 2
Mesh Corrosion & Temp. Considerations

Material	Spec. Grav.	Max. Op. Temp., °F	Typical Surface
304 SS	1.00	---	Petroleum, aqueous
304L	1.00	---	Petroleum, aqueous
316L	1.00	---	Sulfuric acid
410 SS	1.00	---	Mild chemicals
Monel®	1.12	---	Corrosive chemicals
Nickel	1.13	---	Caustic evaporators
Alloy 20	1.00	---	Sulfuric acid
Glass	2.52	---	Mild aqueous chemicals
Hastelloy®	1.14	---	Hydrochloric & other acids
Dacron®	1.38	350	Co-knit applications
Kynar®	1.75	300	Acid, alkali
Polypropylene	0.90	160	Water, acid, alkali
Teflon®	2.15	400	Hot sulfuric acid up to 300°F
Tefzel®	1.70	380	Acid, alkali

Design Equations

To determine mist eliminator cross-sectional area (and hence vessel size) and predict performance in terms of removal efficiency, the optimum design gas velocity is determined first. The Souders-Brown equation is used to determine this velocity based on the physical properties of the liquid droplets and carrying vapor:

$$V_d = k(\rho_L - \rho_G / \rho_G)^{1/2} \quad (1)$$

where V_d = design gas velocity (ft/sec)
 k = Capacity Factor (ft/sec)
 ρ_L = Liquid Density (lbs/ft³)
 ρ_G = Vapor Density (lbs/ft³)

The capacity factor is determined through experience and for each application, and is influenced by type and style of mesh or vane targets used, the geometry of the targets (vertical or horizontal relative to the vapor flow), as well as by properties such as operating pressure, fluid viscosities, and liquid surface tension.

The design velocity V_d for a given application is the value that produces the best performance in terms of capturing droplets and avoiding re-entrainment. Referring to Figure 8, this ideal velocity for a given class of mist eliminators would be somewhere toward

the upper end of the range: about 10 fps for plain wire mesh pads, about 8.5 fps for co-knits, and 14 fps for Plate-Pak™ elements. As discussed, effectiveness drops off at lower velocities as the droplets have sufficiently low momentum to negotiate paths through the targets, and at higher velocities because the vapor carried sufficient kinetic energy to re-entrain droplets. For typical designs, acceptable velocities range between 25% to 125% of the ideal value.

The Capacity Factor may be thought of as an indication of ability of a mist eliminator to drain liquids and avoid re-entrainment under various conditions. See Table 3 for some typical baseline values.

TABLE 3
Standard Souders-Brown Coefficients (k factors) for mesh and Plate-Pak™ Units

Pad Arrangement	k, ft/sec
1. Horizontal Style 4CA pad	0.35
2. Style 4CA MisterMesh® Pad	0.42
3. Horizontal Plate-Pak™ Unit <i>With or without MisterMesh® Pad below</i>	0.50
4. Vertical Plate-Pak™ Unit <i>With or without wire mesh ahead</i>	0.65

NOTE: Water and air, room temperature, pressure below 100 psia

Note that Souders-Brown equation provides correction for only gas and liquid densities. Should any conditions exist which affect drainage or re-entrainment, the Capacity Factor must be pro-rated as appropriate.

After selecting the appropriate Capacity Factor and calculating the ideal vapor velocity, the cross-sectional area of mist eliminator is readily determined by dividing the volumetric flow rate by the velocity.

Having established this design velocity for the application, you can now predict the efficiency of a mesh pad for droplets of a particular size. This procedure is laborious and therefore well suited for a computer.

First, calculate the inertial parameter K as follows, using consistent units of measurement:

$$K = [(\rho_L - \rho_G)Vd^2] / 9\mu D \quad (2)$$

Where **K** = dimensionless inertial parameter

V = gas velocity in fps

d = Liquid droplet diameter in ft

μ = Gas viscosity in lb/ft sec

D = Wire or filament diameter in ft

Use this calculated K value with Figure 12 to find the corresponding value of the impaction efficiency fraction E. From Table 1, find S, the specific surface area for the mesh style of interest.

Subsequently determine SO of the mist eliminator perpendicular to vapor flow and with a correction factor of 0.67 to remove that portion of the knitted wire not perpendicular to the gas flow:

SO = Specific Surface Area x 1/ π x Thickness (ft) x 0.67
Using these values and T, the thickness of the pad, calculate the capture efficiency:

$$\text{Efficiency \%} = 100 - (100/e^{ESO})$$

Where **SO** = Corrected Pad Specific Surface Area, ft²/ft³

E = Impaction efficiency fraction

This efficiency is the percent of all incoming droplets of the given diameter which will be captured rather than passing through the mist eliminator. The percentage will be higher for larger droplets and lower for smaller.

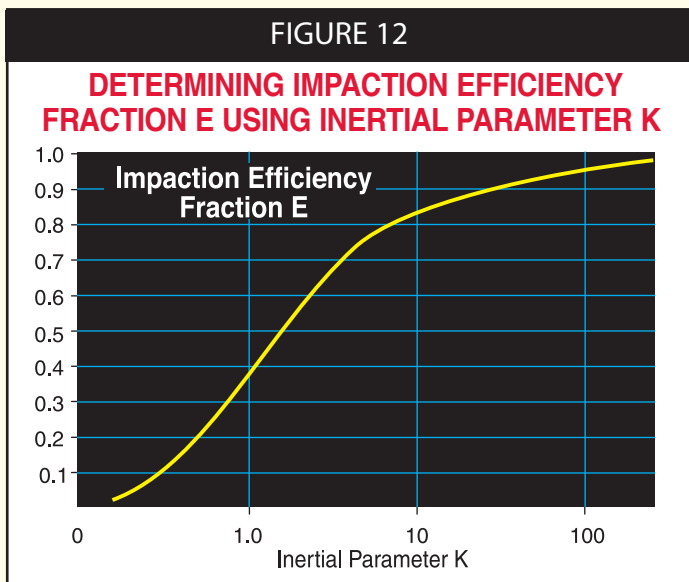

Predicting Pressure Drop

Although the operating pressure differential across a properly sized mesh pad or vane is never more than a few inches of water, pressure drop is an important

design consideration in certain applications, particularly vacuum systems or larger columns requiring the movement of great quantities of gas. It has been shown that each inch of head loss requires some 0.16 hp/scfm. A simple correlation has been developed to describe the pressure drop through a dry mist eliminator (no mist):

$$\Delta P_{\text{dry}} = 0.4VD^2 \rho_G ST / g_c \epsilon \rho_w \quad (3)$$

Where **V** = Gas Superficial velocity = Ft / Sec

ρ_G = Gas Density lbs / ft³

S = Specific surface area of mesh ft² / ft³

T = Mesh Pad Thickness - Ft

G_c = gravitational constant, 32.2 ft / sec²

ϵ = Mesh Void Fraction

ρ_w = Ambient Density of water — lbs / ft³

Note: Applicable for wire diameter 0.0045" to 0.015".

The overall pressure drop is the sum of the head loss incurred as the gas travels through the mesh, as well as that due to the resistance to captured liquids. Liquid accumulates as a pool in the bottom of the mist eliminator. If the liquid loading and velocity are such that a 2" deep pool accumulates in the bottom of the mesh pad, this amount must be added to that calculated using Equation 3. Figure 13 summarizes pressure drop and velocity test data collected on the AMACS pilot plant for light and medium liquid loading.

With due consideration given to the mist eliminator itself, the flow of fluid to and from it requires the same attention.

Inlet Diffusers

At high flow rates, primary removal of bulk liquids upstream of the mist eliminator is very important to prevent flooding. This is typically done in a cost effective manner by using a simple inlet diverter as shown in Fig. 15.

With this design, liquids impinge upon the diverters, the flow is forced to flow laterally to allow bulk liquids to escape by gravity and eliminate the countercurrent momentum of the gas.

The *Force of Inertia*, expressed as ρv^2 , is typically used to quantify the flow entering a vessel to determine whether a simple baffle will suffice. AMACS recommends inlet diverters to a Force of Inertia up to 2,500 lb/ft s². Above this, more sophisticated distributors are recommended.

FIGURE 13

ACTUAL PRESSURE DROP VERSUS VELOCITY FOR TYPICAL AMACS MESH PADS AT LIGHT AND MEDIUM LOADS

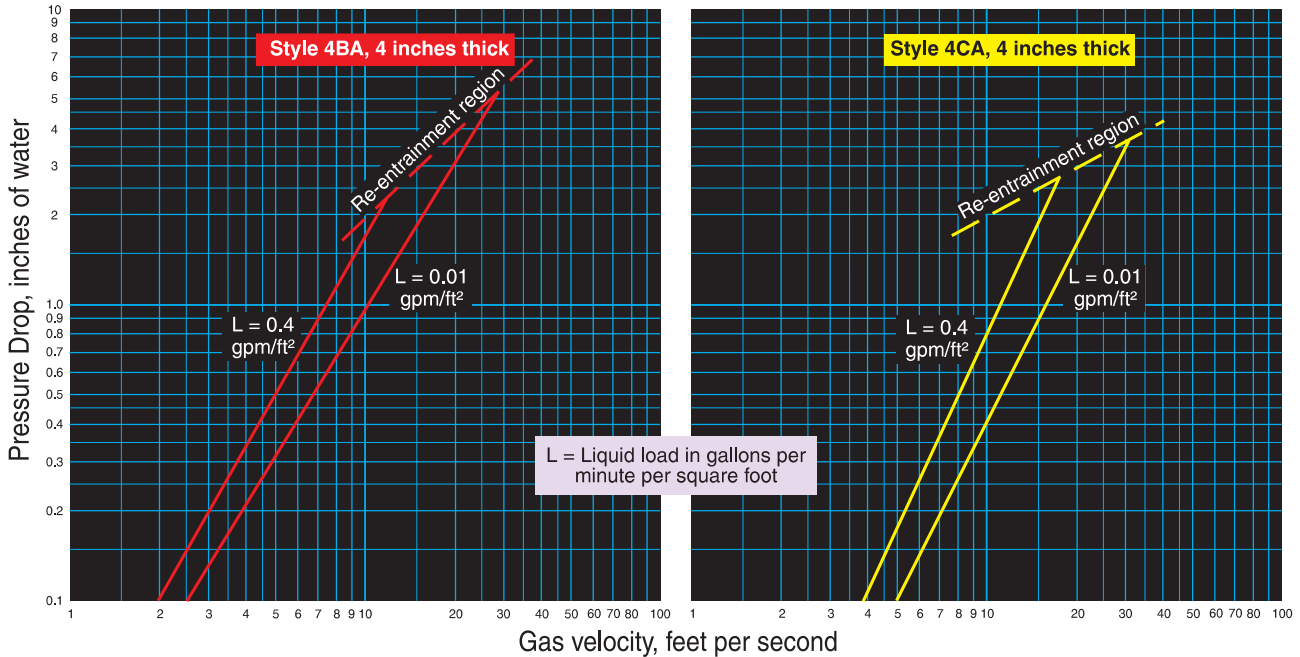

Decades ago, Dutch Shell Chemical Company introduced Schoepentoeter® style bladed designs (Fig. 14).



As the fluid flows axially towards the shell opposite of the inlet nozzle, liquids are captured by specially placed blades. This design is superior because it allows the escape of liquids over a much greater

region of the vessel. A simple inlet diverter (Fig. 15) would simply shear bulk liquids into smaller droplets at great flow rates:

AMACS AccuFlow™ Inlet Diffuser (Fig. 16) is a similar style of the bladed design in which the body of the diffuser maintains its shape, the restriction of flow which allows the escape



of liquids over the diameter of the vessel is accomplished using internal blades of concentric and decreasing cross-sectional areas.

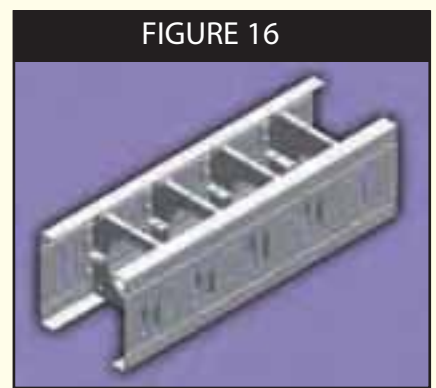

Vessel Configuration

Several factors must be considered when deciding on the configuration of vessel internals. The first step is to determine the cross-sectional area needed. Then a tentative geometry and shape appropriate for both the vessel and plant location is selected. Figure 17 shows the most typical, but by no means complete, configurations. Mist eliminators can be of virtually any size or shape to accommodate all factors.

The performance of the mist eliminator depends strongly on an even velocity distribution over the cross-sectional area. As a general rule, a distance of either half the vessel diameter or 72", which ever is smaller, is sufficient spacing both upstream and downstream of the element. Representations for specific cases are illustrated in Figure 18.

FIGURE 17

SIMPLIFIED VIEWS OF TYPICAL MIST ELIMINATOR CONFIGURATIONS IN SEPARATOR VESSELS

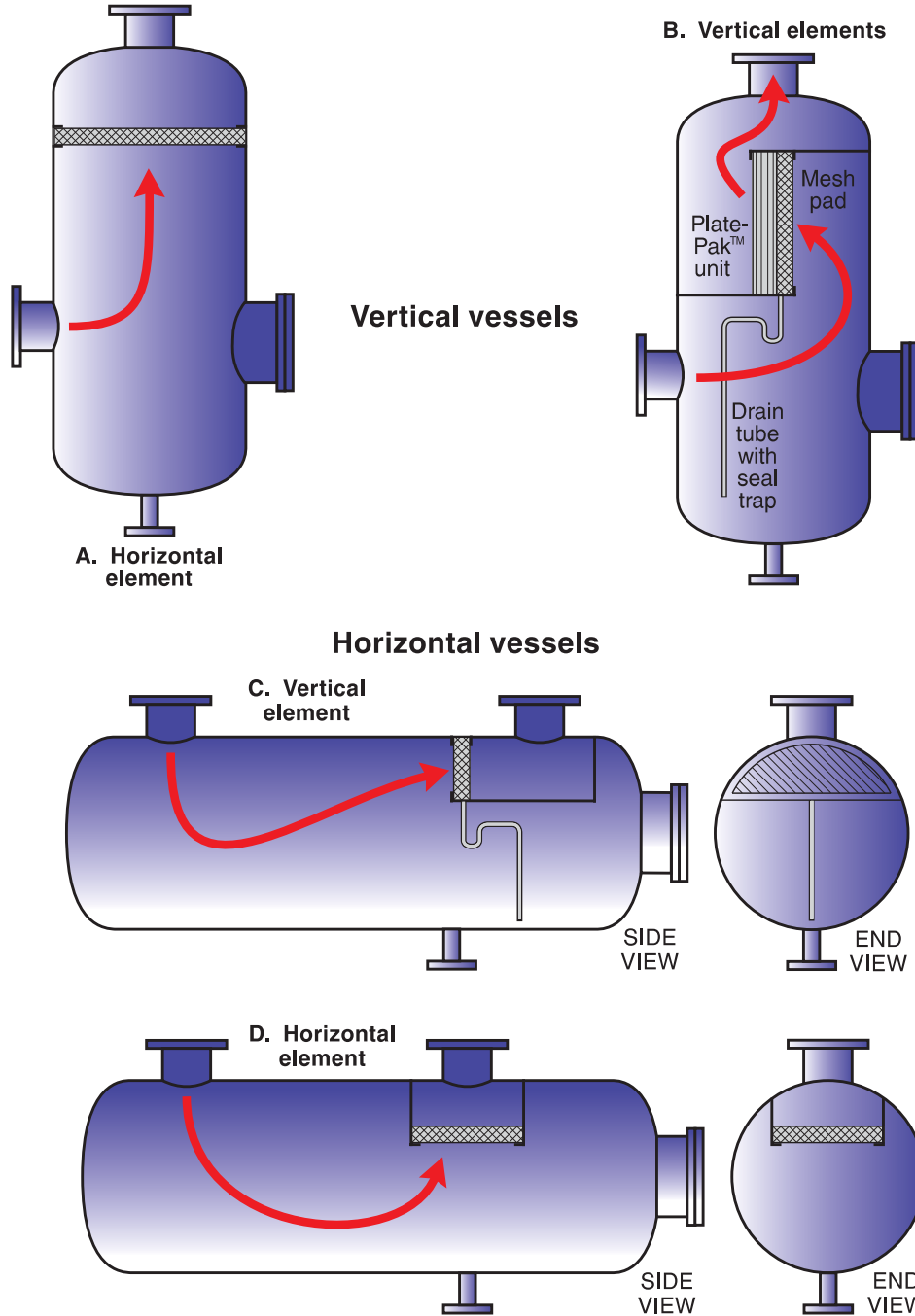

Small velocity differences across the surface are acceptable, but should be minimized at the design stage. Otherwise, some regions of the mist eliminator may be subjected to heavy loading leading to re-entrainment while other regions are unused.

Most often, the mist eliminator is located just upstream of the outlet nozzle with insufficient disengagement space. Vapor tends to channel through the

pad in the region closest to the outlet nozzle and peripheral regions of the pad remain unused. To rectify this, AMACS engineers apply an *Integral Flow Distributor* which is welded to region(s) of the downstream face of the pad. This technique allows the engineer to selectively increase the pressure drop through regions of the pad likely to suffer from channeling, and is cost effective.

Advanced Mist Eliminator Designs

There are several modifications to mesh pads and vanes to dramatically enhance performance.

FIGURE 18

Guidelines for maintaining even flow distribution across mesh pads or vane units with axial flow in cylindrical vessels. Height of vessel head is assumed to be 1/4 of vessel diameter. Flow distribution devices can minimize required disengagement space above mesh pads. Contact AMACS for assistance.

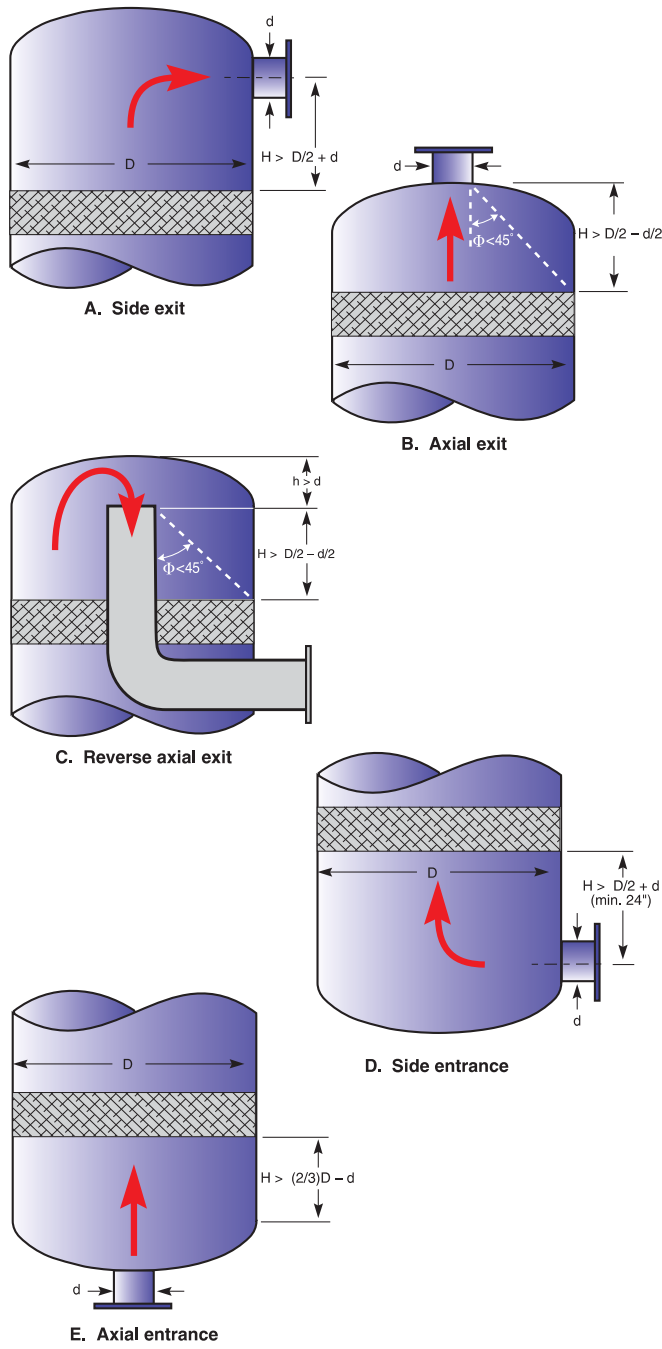

Drainage & Collection Layering

Recall the discussion on pressure drop through a mist eliminator in which liquid tends to pool in the lower layers of mesh. The simplest technique to promote drainage is to use a few inches of open, porous mesh such as AMACS style 7CA (5-lb density with specific surface area as low as 45 sq-ft/cu-ft) in the upstream position. As drainage occurs through the interstitial regions of the mesh, opening the knit enhances liquid drainage.

FIGURE 19

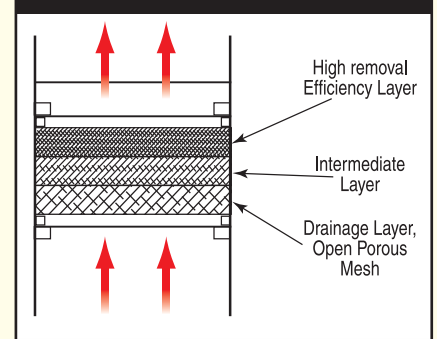

An extension of this approach is to use higher specific surface area mesh in downstream positions to enhance separation efficiency, with intermediate mesh between the collection and drainage zones. Figure 19 illustrates a multilayer mist eliminator.

Figure 19 illustrates a multilayer mist eliminator.

MisterMesh® Drainage Coils

A second technique used by AMACS to enhance liquid drainage, and often in conjunction with multi-layering, is to append drainage coils to the upstream face of a horizontal mist eliminator as shown in Figure 20. The coils are also made of mesh and "fill" with liquid.

FIGURE 20



Once filled, liquid from the pad above is drawn by gravity and The Coanda Effect to the coils, thereby establishing distinct regions for liquid drainage and liquid collection in the upstream layers. Figure 21 compares the pressure drop and flooding point of both conventional and MisterMesh® Mist Eliminators.

Mesh-Vane Assemblies

In grass root design of larger vessels and retrofit of existing ones to accommodate greater flow rates, mesh-vane assemblies are often used. In an assembly, mesh is placed upstream of the vane and acts as a flooded agglomerator. The capacity factor used corresponds to the downstream vane element. This approach combines the efficiency of mesh with the capacity of vanes and has been used by AMACS engineers with tremendous success over the past two decades.

FIGURE 21

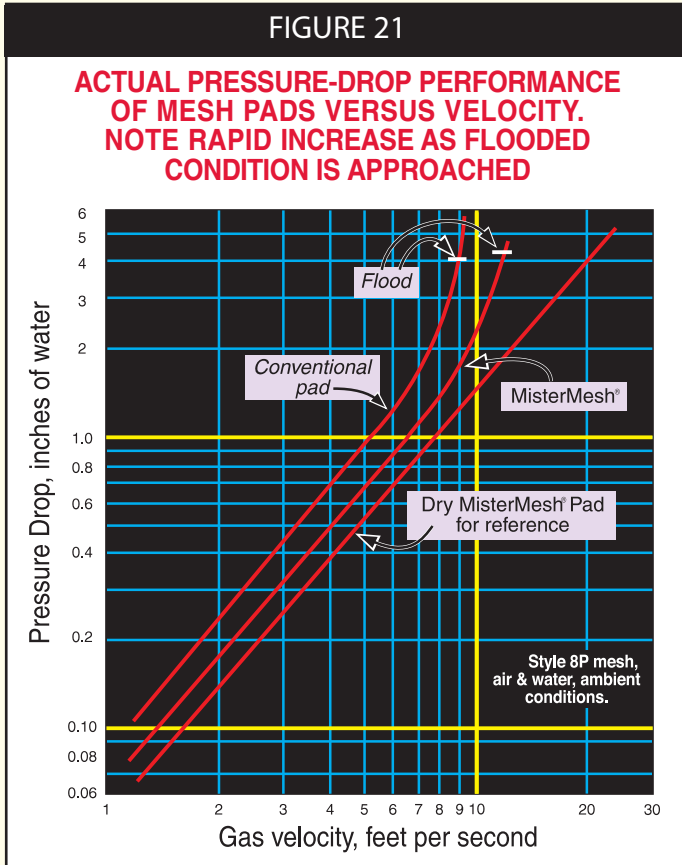

Throughout the industry there is ongoing debate as to whether the mesh should be positioned up- or downstream of the vane element. Engineers at AMACS have performed exhaustive comparative testing on pilot plants and have much field data proving that the mesh is indeed affective upstream of the vane, unless the vane element is used as a pre-filter to protect a downstream mesh pad.

Use of Geometry

Another approach used in the industry when the size of the vessel is limited is to arrange the mist eliminator at an angle. The capacity increase is equal to the sine of the angle though it should not exceed 45°. This is

shown in Figure 22 for smaller and larger diameters. An AMACS engineer should be consulted for such designs.

FIGURE 22

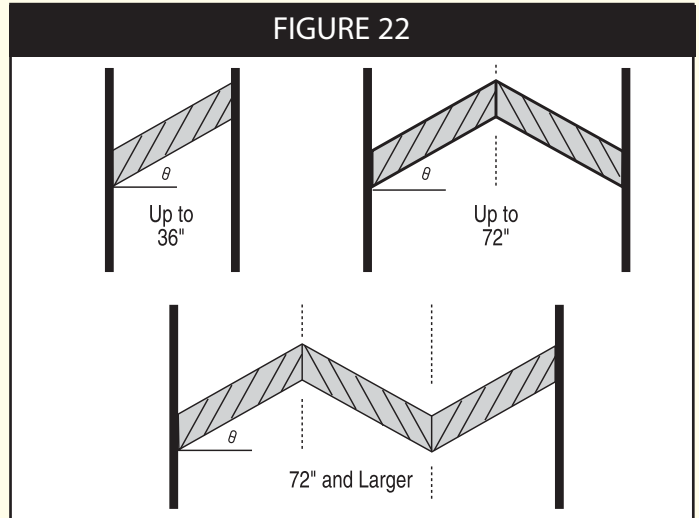

MultiPocket® Vanes

The capacity of vertical vanes (with horizontal vapor flow) can also be increased by enhancing liquid drainage. As discussed, captured liquids are re-entrained when the velocity of vapor exceeds the ideal. To prevent liquid re-entrainment, the serpentine path offered by the vane is augmented with obstructions to allow for the pooling of liquid with protection from the passing vapor stream. This design increases the capacity of the vane by as much as 25%. In vertical gas compressor knock-out drums, in which the vessel size is dictated by the capacity of the mist eliminator, MultiPocket® Vanes considerably reduce the Foot-print and cost of skids.

Figure 23 summarizes the approaches used by AMACS and the reduction in vessel dimensions possible using these advanced designs.

The MultiPocket® Vane has been patented by AMACS.

FIGURE 23

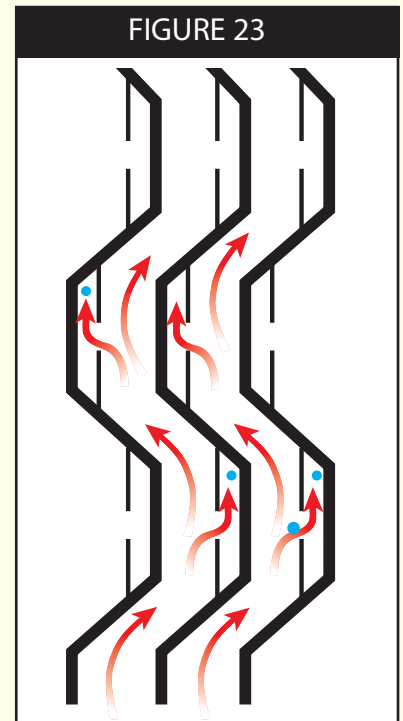

Pockets Improve This Mist Eliminator's Efficiency

ACS Industries, Inc (Now AMACS Process Tower Internals) was awarded US Patent #6,852,146 for a vane-type mist eliminator that removes entrained liquid droplets from high-velocity gas streams. Available commercially as the MultiPocket® vane assembly (Figure), it comprises a sheet fabricated from one piece of metal and featuring parallel rows of serpentine-like vanes. These sheets are held in their arrangement by bolts and spacers, not welds, as used in conventional designs. "This design prevents corrosion caused by internal welding and tight radius bends common in other high performance vane designs," says Kanti Patel, ACS engineering manager.

The vane blades are configured in such a way as to create pockets that allow droplets entrained in a gas stream to impinge and cling to the vane, and then drain, without being re-entrained. With horizontal flow, the separated liquid drains perpendicularly to the gas stream, thereby preventing gas-liquid traffic below the Plate-Pak™ vanes. This feature allows higher flows. Third party testing shows that the MultiPocket® vanes exhibited a 3.4 – 14.1% capacity increase before breakthrough (liquid carryover) occurs downstream.

For any given installation thickness of the vanes, the number of pockets, spacing of the vanes, and other parameters can

be varied to achieve the desired separation. The prefabricated unit comes in either a single piece ready for installation, or in smaller sections that can be installed through a vessel manway. To complete the installation a fabricated housing and a liquid drain are added, followed by welding or bolting of the entire unit in the vessel.

Gaston Rodriguez, process equipment proposals manager at the Hanover Co. (Houston, TX; www.hanover-co.com) provided the following case data in support of the MultiPocket® vane. A recent application for this product was in a vertical 2-phase scrubber handling 125 million ft³/d of natural gas at an operating pressure of 350 psig and 90°F. Using the MultiPocket® vane allowed for the reduction of the vessel diameter from 60 inches to 54 inches. The material, labor and installation savings was \$6,500.

In other applications where pressure drop is critical, such as gas pipeline and utility contracts, the MultiPocket® vane provides the minimum pressure drop at the highest mist elimination efficiency. Tests has shown that for an inlet water spray loading of 2 gpm/ft² and air velocities of 10–25 ft/s, the pressure drop for a horizontal orientation is about 15% less than with the conventional vane.

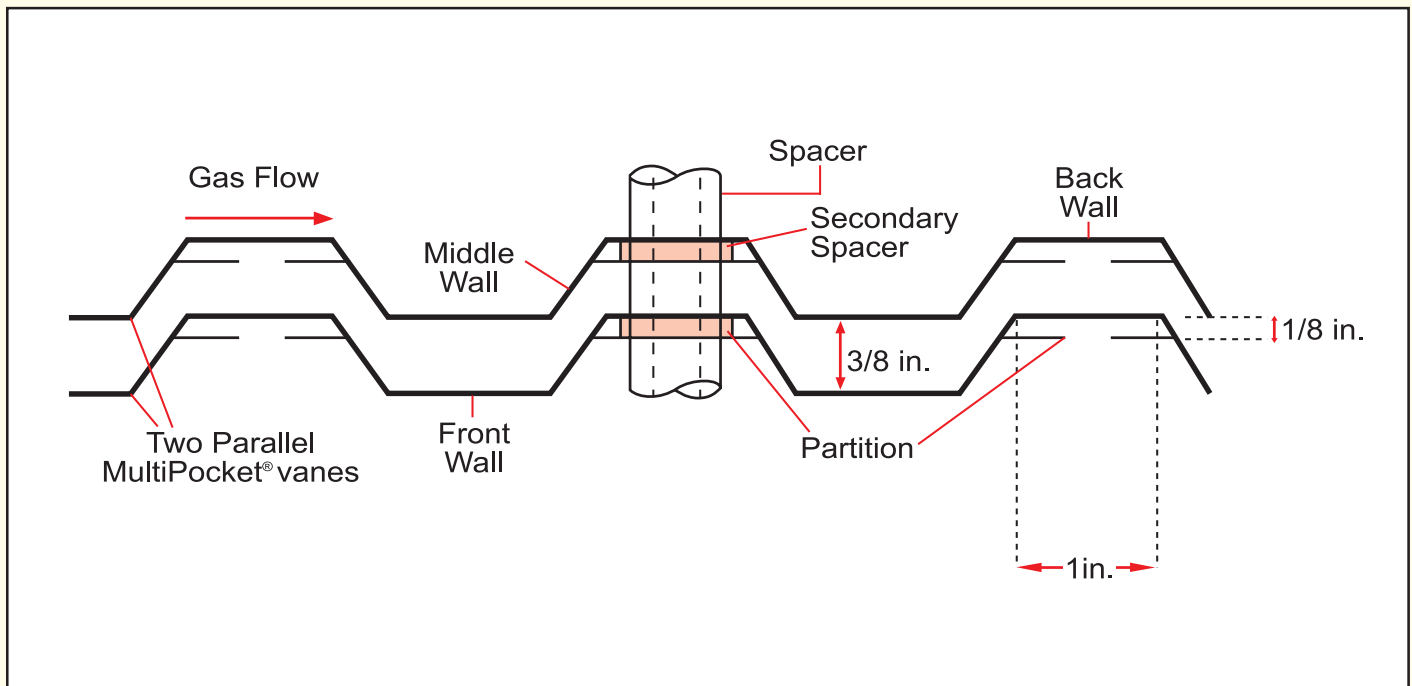

The MultiPocket® vane is a thin sheet that is formed into hills and valleys. The gas stream enters one side and takes a zig-zag path to reach the other side. Pockets formed by partitions allow droplets entrained in a gas stream to impinge and cling to the vane, and then drain, without being re-entrained.

MistFix[®] Insertion Mist Eliminators



Mist Eliminators



MistFix[®] U.S. Patent #5985004

The patented AMACS MistFix[®] can solve carryover problems in vessels without a mist eliminator, as well as in vessels with a less efficient or damaged mist eliminator.

In existing vessels that do not have a manway, the MistFix[®] Insertion Mist Eliminator is an ideal choice. It is suitable for any vessel having an 8" or larger gas outlet nozzle at the top. It also eliminates the need for hazardous entry permits. Since there is no need to enter the vessel, this drastically reduces downtime, resulting in quicker turnarounds, reduced maintenance cost and production gains.

MistFix[®] also eliminates the need for modifications to vessels. For new vessels MistFix[®] may eliminate the need for a manway and reduce vessel cost. It also makes future maintenance easier and simpler.

AMACS MistFix[®] can easily be installed and replaced from the outside. Existing vessels require no modifications to accommodate the MistFix[®].

Advantages:

- No Cutting of existing vessel
- No Welding
- No Hazardous Entry
- No ASME re-certification
- No Scaffolding
- Minimal Downtime

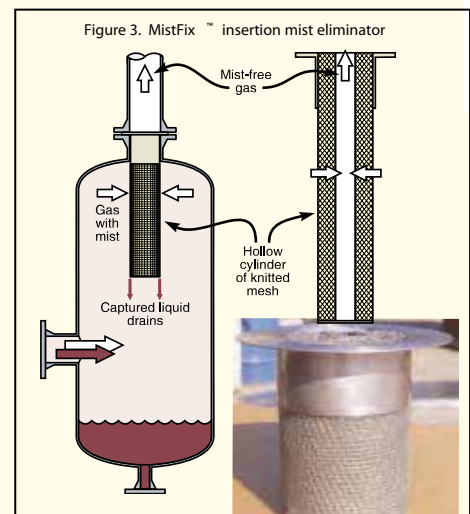

For more information please call:

1-800-231-0077

www.amacs.com



Amistco Separation Products Inc, and ACS Separations and Mass Transfer Products, are Registered Trademarks of AMACS

THE ENGINEERED MIST ELIMINATOR

13

MAXCAP®

mist eliminator with **43%** more capacity



Our engineers have developed a new mist eliminator that has more vapor handling capacity than any other in-kind replacement pad on the market today. Its unique geometric construction allows liquid to drain with lower pressure drop performance than other pads. Efficiency is gained, not lost. Price-wise...the new maximum capacity pad costs about the same as other MisterMesh® mist eliminators.

MisterMesh® and MultiPocket® are registered trademarks and Plate-Pak™ and MaxCap® are registered trademarks of AMACS Process Tower Internals.

*The MaxCap® mist eliminator is generally used for replacing conventional mesh pads and is recommended only for vertical flow service. The MaxCap® mist eliminator is currently only used separately; not in a mesh-vane combination.

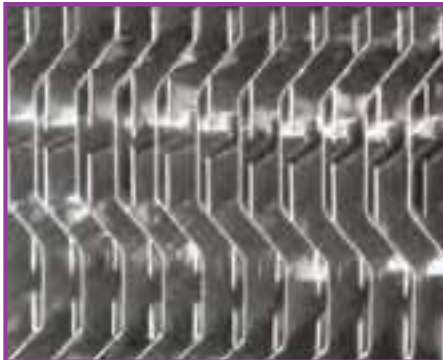

When you need something stronger than mesh... Try AMACS Plate Pak vane or MultiPocket® vane. Not only are our vane mist eliminators tough (they are constructed of high-grade steel), but they also perform at very high vapor loads (they're often used to boost the liquid capacity of mesh pads). These specialty vane units can be used without a pad in either a horizontal or vertical flow configuration. They are designed to catch more droplets, and reduce eddy turbulence. As a result, they are more efficient, have more through-put, and cause less pressure drop than other similar products available today. Even though our vanes are normally supplied in stainless steel, we can provide them in almost any metal alloy or surface finish to resist even the most corrosive (and abrasive) service conditions. (US Patent 6,852,146)

Call us today to see if the new MisterMesh® MaxCap® mist eliminator can help you increase your vessel's service capacity or to find out if the AMACS vane or MultiPocket® vane might be a better solution for your next demanding mist elimination service.



ON-SITE ENGINEERING & FABRICATION FOR ALL YOUR VESSEL & TOWER INTERNALS



FIGURE 24

APPLYING COMBINATIONS OF AMACS MESH PADS AND PLATE-PAK™ VANE UNITS TO MINIMIZE VESSEL SIZE

Option A:
Conventional
horizontal pad

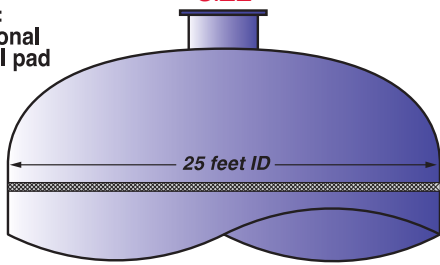

Option B:
MisterMesh® pad

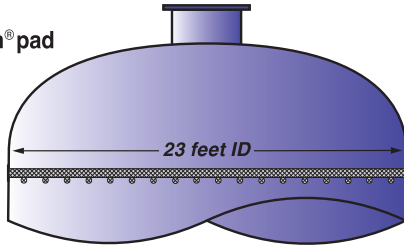

Option C:
MisterMesh®
pad and Plate-Pak™ unit

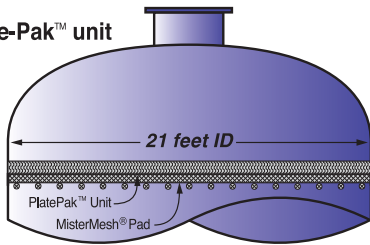

Option D: Vertical box unit, mesh and Plate-Pak™ unit

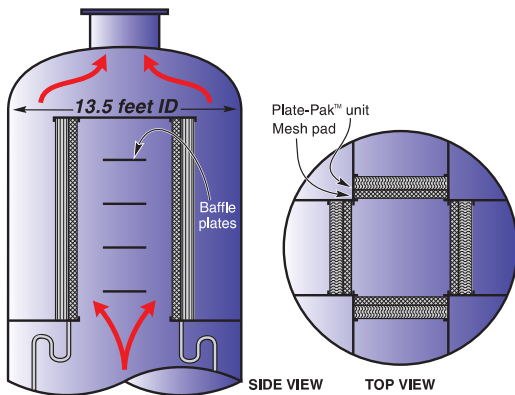

Option E: Double vertical bank, mesh and Plate-Pak™ unit

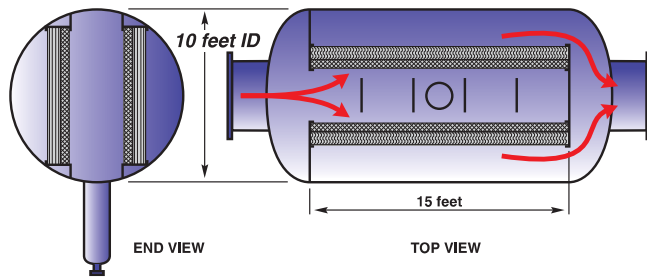

CASE STUDIES & EXAMPLES

Case Study Number 1

Problem: In an HCl scrubber, an air stream of 60 acfs is coming off a bed of random packing and contains droplets of a weak acid. The unit operates at 122 psia at 82°F. Determine the size of mist eliminator required to remove this mist and the removal efficiency possible.

Solution: Since the acid is dilute we assume the density and viscosity of water at the operating pressure and temperature:

$$\begin{aligned} \rho_L &= 62.4 \text{ lb/ft}^3 \\ \rho_G &= 0.60 \text{ lb/ft}^3 \\ P &= 122 \text{ lb/ft}^2 \\ T &= 82^\circ\text{F} \\ F &= 60 \text{ ft}^3/\text{sec} \end{aligned}$$

The first step is to select the mist eliminator type and mesh style. As shown in Figure 24, mist coming to the mesh pad is typically comprised of droplets ranging in size from as small as 5 μm, so we select a mesh style mist eliminator to achieve this level of performance. From experience, the capacity factor for poly mesh at moderate liquid loading and lower pressures is ~.27 fps. Using the Souders-Brown equation the ideal velocity is calculated:

$$\begin{aligned} V_{\text{ideal}} &= k [(\rho_L - \rho_G) / \rho_G]^{1/2} \\ V_{\text{ideal}} &= 0.27 [(62.4 - 0.60) / 0.60]^{1/2} \\ V_{\text{ideal}} &= 2.74 \text{ fps} \end{aligned}$$

The cross-sectional area of mist eliminator is determined by dividing the volumetric flow rate by the ideal velocity:

$$\text{Area Mist Eliminator} = \frac{\text{Volumetric Flow Rate}}{\text{Superficial Vapor Velocity}}$$

$$\text{Area Mist Eliminator} = [60 \text{ ft}^3/\text{sec}] / 2.74 \text{ fps}$$

$$\text{Area Mist Eliminator} = 21.9 \text{ ft}^2$$

The corresponding diameter is 63.4", rounded up to a standard 66" scrubber vessel. Note that performing the same calculations using a vane (and a capacity factor of 0.50) yields an ideal vessel diameter of 46.7", rounded up to a standard 48" ID vessel. To calculate the removal efficiency at 5 μm, several parameters must be identified to use equation 2 to determine the inertial parameter K:

$$K = [(\rho_L - \rho_G)Vd^2]/9\mu D$$

$$K = 0.32 \text{ fps}$$

From Figure 12, the corresponding Impaction Efficiency Fraction E is ~0.08. In the Removal Efficiency Equation there is a term for the corrected specific surface area SO:

$$SO = \text{Specific Surface Area} \times 1/\pi \times \text{Thickness (ft)} \times 0.67$$

For ACS style 8P, the specific surface area is $(185 + 36) = 221 \text{ ft}^2/\text{ft}^3$, we will try both 4" and 6" thick mist eliminator thicknesses (1/3 and 1/2ft):

$$SO = 221 \times 1/3.14 \times 1/3 \times 0.67$$

$$SO_{4''\text{thick}} = 15.7 \text{ and } SO_{6''\text{thick}} = 23.6$$

And Removal Efficiency E at 5 μm is:

$$\text{Efficiency} = 100 - 100/e^{ESO}$$

$$\text{Efficiency} = 100 - 100/e^{(0.08)(15.7)}$$

$$\text{Efficiency} = 71.5\%$$

For the 6" thick element, the removal efficiency is 84.8%. By using a composite pad containing a 2" layer of regular monofilament polypropylene, style 8P, upstream of a 2" thick layer of 8PP, mono- and multi-filament co-knit, the removal efficiency is 99.9% .

CASE STUDY #2

Traditionally, trays are used to bring about contact between glycol and natural gas in dehydration contactors. In recent years, the industry moved towards smaller diameter columns by exploiting the higher capacities achieved with structured packing. However, the lower capital investment associated with a smaller diameter packed tower is often offset by dramatically increased glycol losses.

Consider a mid-western sour gas plant operating a 96" glycol contactor and processing 1,310,000 lb/hr of gas at 116°F and 1214 psia. The gas and liquid specific densities were 4.4 and 68 lb/cu-ft respectively. The plant was experiencing 0.13 US gal of carryover per mmscf, amounting to some 65 gal/day of lost triethylene glycol, several hundred dollars worth per day. A 10" thick wire mesh mist eliminator of 12-lb mass density was installed above the packing.

From experience, AMACS engineers knew that the droplet size distribution for glycol coming off the top of a packed dehydrator extends down to diameters of 5 μm and greater. Also, if the diameter of the packed column was sized in accordance with the hydraulic requirements of the packing, the wire mesh mist eliminator would be undersized.

The capacity factor for 12-lb density mesh in this service is ~0.23 – 0.27, having been de-rated for the high liquid viscosity of 18 cP (which retards liquid drainage) and relatively high operating pressure. Using the gas density, volumetric flow rate and cross-sectional area of the mist eliminator, the actual superficial velocity is readily calculated. Next, using known densities of the gas and glycol, the actual or operating Capacity Factor k is determined:

$$V_{\text{actual}} = k_{\text{actual}} [(\rho_L - \rho_G) / \rho_G]^{1/2}$$

$$\text{Re-arranging for}$$

$$k_{\text{actual}} = V_{\text{actual}} / [(\rho_L - \rho_G) / \rho_G]^{1/2}$$

$$= 0.44 \text{ fps}$$

A Capacity Factor of 0.44 fps is almost twice as high as the optimum, and is in the range of that of an AMACS Plate-Pak™ Vane mist eliminator. However, the vane will not remove particles down to 5 μm, so a mesh-vane assembly was proposed. The assembly has a multiple layers of mesh. The first layer is composed of highly porous mesh (AMACS style 7CA), followed by a layer of the high specific surface area (AMACS style 8DT) co-knit mesh of stainless and Dacron® Fibers. MisterMesh® drainage coils were appended to the bottom face of the mist eliminator. Downstream of the mesh was placed a Plate-Pak™ vane. The total thickness was 12" and was accommodated using the same supports as the mist eliminator it replaced.

Carryover from a glycol contactor occurs through two mechanisms, evaporative losses and mechanical (carryover losses). In this example, simulations showed evaporative glycol losses of 0.0054 gal/mmscfd. The total losses after the revamp were less than 0.008 gal/mmscfd, and carryover losses had been reduced from 0.13 gal/mmscfd, a 94% reduction!



14211 Industry Street, Houston, Texas 77053
 Telephone: (713) 434-0934 or (800) 231-0077
 Fax: (713) 433-6201 • E-mail: amacs@amacs.com
 Website: www.amacs.com

TECHNICAL DATA SHEET • MIST ELIMINATOR

COMPANY INFORMATION

Company:	Contact (Name/Title):
Address:	TEL: () FAX: () E-mail:

STATE YOUR MIST ELIMINATOR APPLICATION

PROCESS CONDITIONS (Provide appropriate units)

Operating Temperature: deg F / deg C		Operating Pressure: psia (psig)	
Gas Type:	Flow Rate: MAX.:	MIN.:	lb/hr/(acfm)
Vapor Density or SG or Mol. Wt.:		Compressibility Factor:	Viscosity: cp
Liquid Type:	Qty.: gpm	Density or SG:	Viscosity: cp
Solids/Foulants: Yes No		If Yes, Explain:	

VESSEL DETAILS NEW EXISTING

Dia:	Ht./Length:
Manway Size:	Horiz.: Vert.
Material:	Housing Required? YES NO

DESIRED SEPARATION

_____ % removal of _____ μ m Droplets
_____ wt% / vol% / ppm in exit gas

MIST ELIMINATOR

Preferred Type: Wire Mesh Vane
Materials:
Remarks:

SKETCH

Notes

A large rectangular box containing 25 horizontal lines for taking notes.

HIGH CAPACITY MIST ELIMINATORS OUT PERFORM CONVENTIONAL TECHNOLOGY!

PLATE-PAK™
MIST ELIMINATOR

MISTER MESH®
MIST ELIMINATOR
WITH DRAINAGE ROLLS



ADVANCED TECHNOLOGY
FOR DEBOTTLENECKING!

Our MisterMesh® Mist Eliminator out performs conventional pads. The drainage rolls accelerate liquid removal thus increasing capacity and reducing pressure drop. Used in conjunction with our Plate-Pak™ vane, the MisterMesh® drain rolls can increase capacity by over 200% while separating droplets down to 3 microns.



AMACS

24-hour emergency service • Free technical support • 50 years experience

800-231-0077

14211 Industry Street • Houston, TX 77053 • TEL: 713-434-0934 • FAX: 713-433-6201
Email: amacs@amacs.com • Visit our web site www.amacs.com